

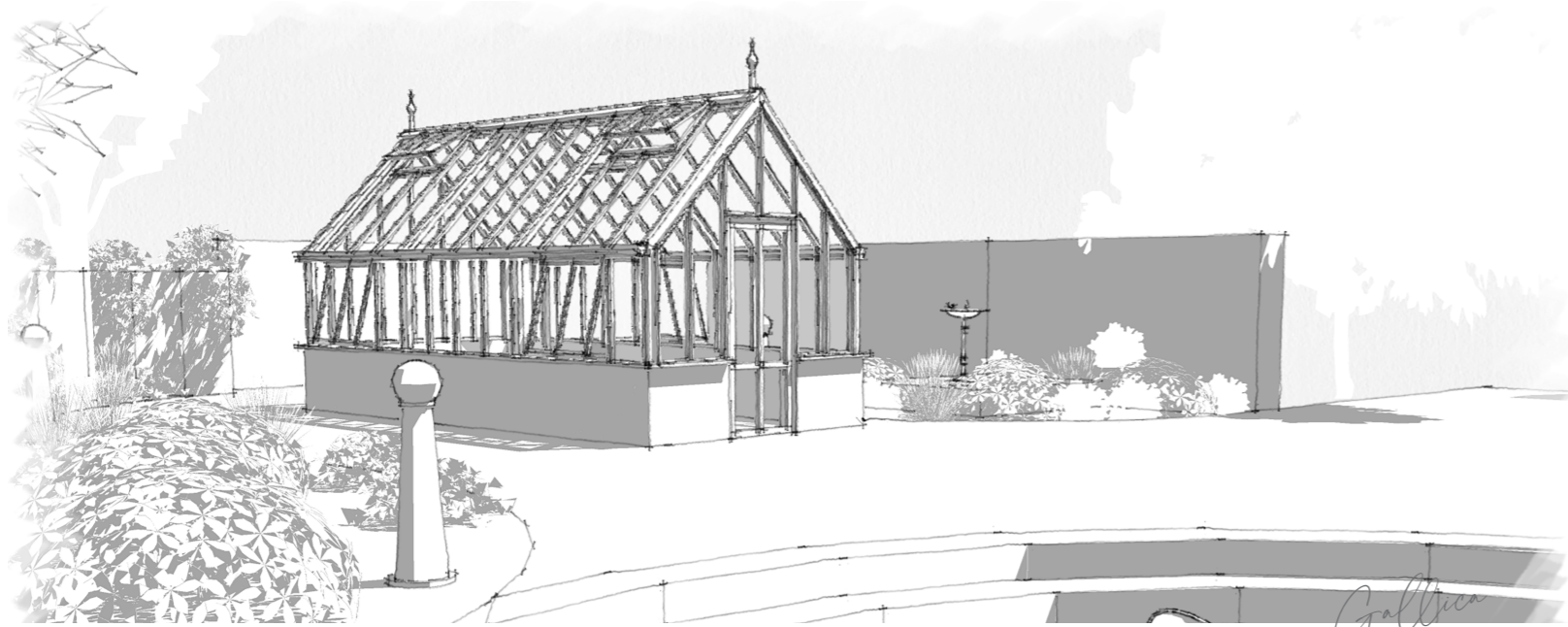

THE ROSE  
GREENHOUSE  
COLLECTION

# GALLICA



Here we find another greenhouse model in an attractive 15 sqm. In this greenhouse we have invested in possibility of maximized cultivation. Plenty of space for you who want seedling beds and really use your greenhouse for home grown goodies.

There is still room for a workbench and, if you want, a smaller seating area for the café table and a moment with a cup tea.



- 15 sqm building area
- 4 mm toughened safety glass
- single door in gable
- dwarf wall 675mm
- 3 roofvents
- 3 face vents

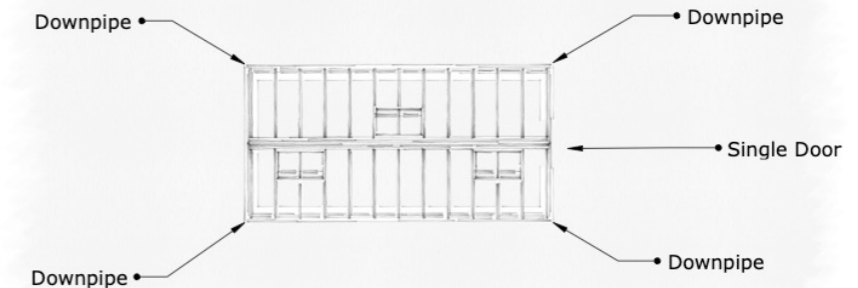
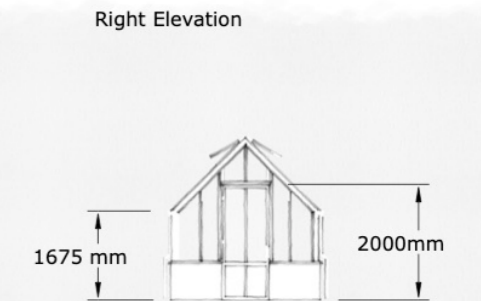
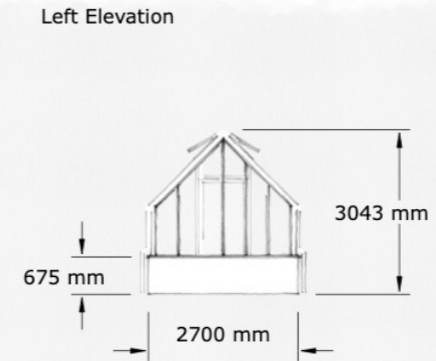
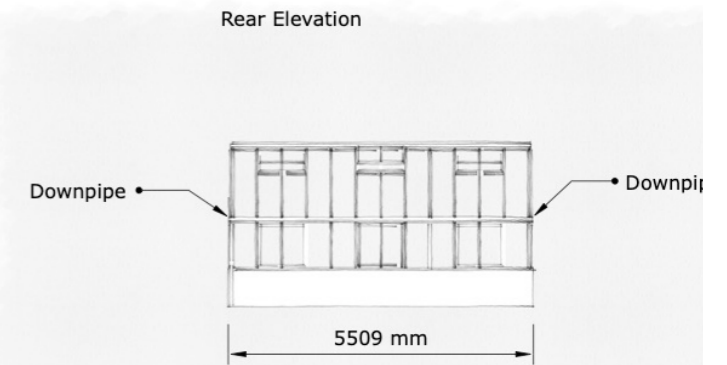
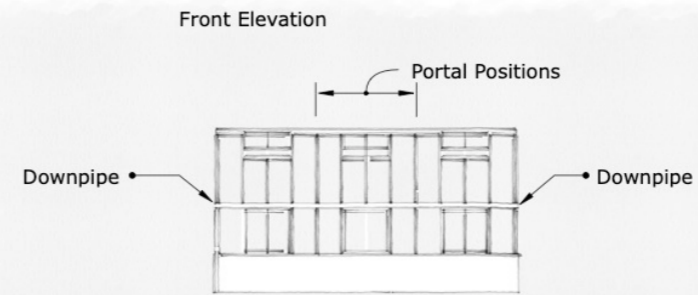



Ridge with decorative finials and optional ridge decoration if desired. Our profile has minimum 2mm thickness and 3mm for all portals and essential parts.

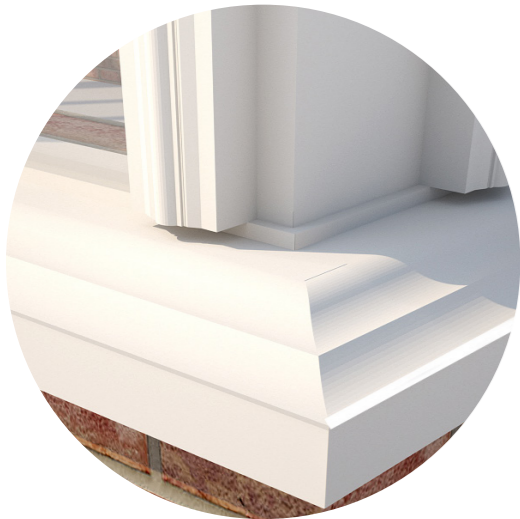

Decorative profile over crown with complete and improved drainage. There are no visible gaskets between glass and profile and no contact between glass and aluminium.

# WE MADE THE BEAUTIFUL MORE BEAUTIFUL AND THE STRONG STRONGER

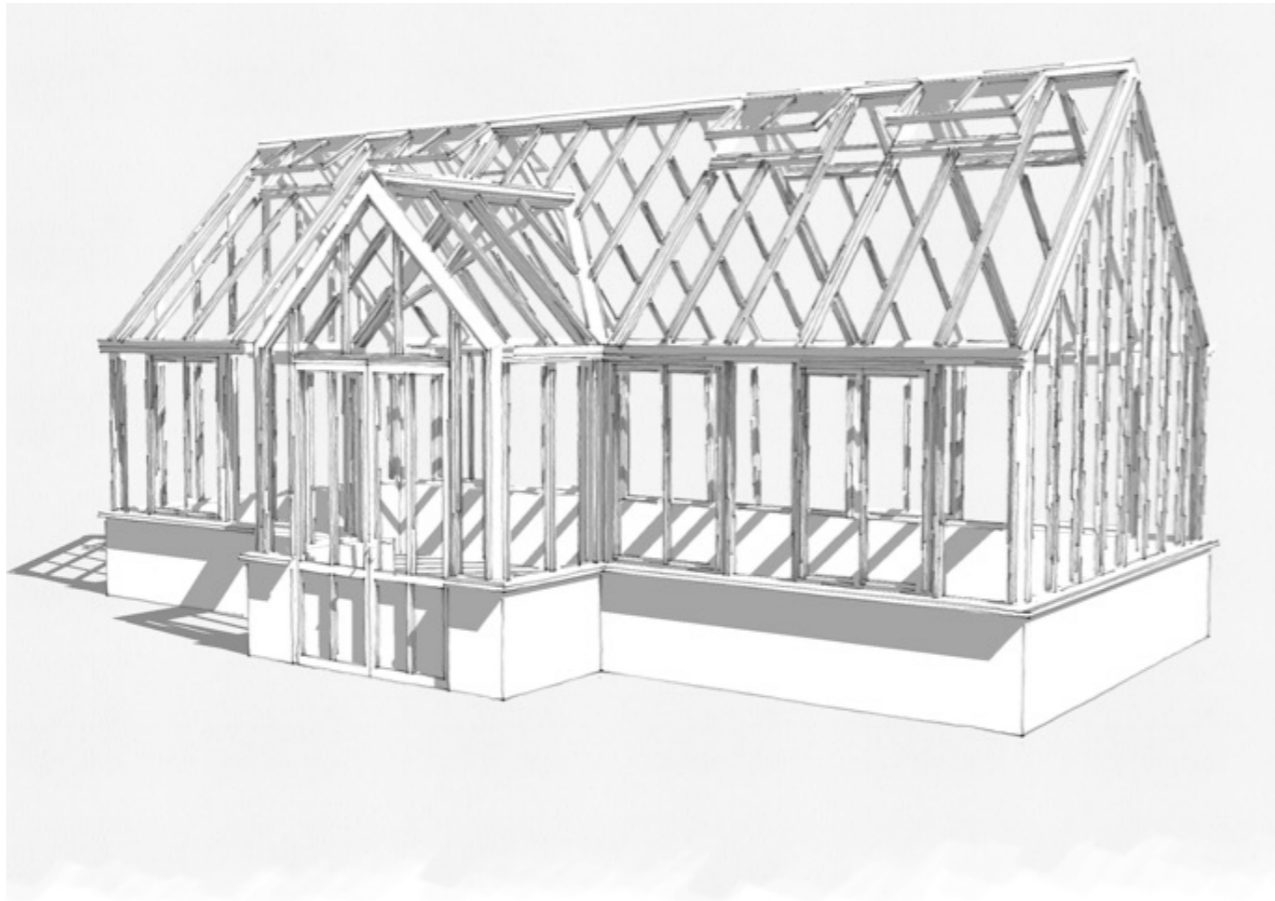

Decorative moldings in both interior walls and roofs make your greenhouse completely free from visible assembly details. If necessary, the roof truss can be reinforced with steel completely hidden in the profile.



Classic Georgian bars between the glazing panels give a light and stately impression whilst preserving the tradition. Perfect fitting, no gaps.



Ventilation along the crest providing a nice and tight finish. Friction hinges for a safe opening and maximized ventilation.



Decorative gutter with improved functions. Integrated downpipes ends and elegantly frames your greenhouse.

# COLOURS



MOSS GREEN

SCANDINAVIAN FOREST



OBSIDIAN BLACK

GRANITE GREY



STRAWBERRY MILKSHAKE

LINGONBERRY & MILK



ELDERBERRY WHITE

CHAMPAGNE WHITE

In the Rose Greenhouse Collection you find handpicked adorable colours which makes your greenhouse unique. Our colours are warm natural according to the plants' own palette, chosen to fit into nature. And what would be a rose collection without mild rose colors...

In addition to our colours, you can of course choose freely from the whole RAL-classic scale. We can also match your greenhouse colour to an NCS code or facade paint.

If you would rather choose your colour from the classic RAL scale, you have the entire colour chart to choose from. Here are some favourites.



RAL 9011

RAL 7032



RAL 7033

RAL 9007



RAL 9010

RAL 9016



RAL 6007

RAL 8022



RAL 3011

RAL 6011

Choosing a colour can be difficult and of course we will help you in your choice. A code can be indicative, but sometimes it requires reading of the colour you want.

Keep in mind that a powder-coated surface is durable and does not fade, the colour remains the same over time. Our powder coating is carried out with the utmost care and has a matte finish if nothing else is desired.

all our powdercoating is made with Qualicoat process.



## ALWAYS INCLUDED

Auto vents with extra storm strength that are controlled solely by the heat in the house and keep your greenhouse ventilated.

Friction hinges in your wall windows. Creates optimal ventilation both at the bottom and top of your window and keeps the window open without support.

Gas-lifters in your cold benches make it easy to open and close your cold benches without hooks.

Any RAL color from our palette or your own request.

Fittings in any metal for both doors and wall windows.

Decor on the ridge or your entire roof.

## ALWAYS INCLUDED IN THE ROSE GREENHOUSE COLLECTION



### RIDGE DECOR

Our ridge decor is a free choice that is included. In our own manufacturing method in a traditional English style spire and lily. If you would like a different design or even your own design on your decor, we can offer this for an additional cost. Nock decor and spire are options that are included in the price, but you can also get your nock without decor.



### FACE VENTILATION

In our wall windows we use friction hinges which enable you to keep your valve open without braces or hooks and with airflow both above and below the valve. The valve closes gently with matching handles. Our wall valves are always included in our greenhouses.

## TILVAL OCH EXTRA



### AUTO VENT

We have chosen to use autovent Megavent for the roof ventilation in our greenhouses for both aesthetic and safety reasons. Megavent® is a compact, yet strong and powerful opener that can lift 70% more than smaller autovents. Due to its compact design, the openers will always be within the frame of the window.

Our megavent comes in a smooth dark gray finish in RAL 7016, aluminum and brass details.



### FITTINGS

Our handles for both doors and valves are made by hand using traditional methods. The design was created especially for the Rose Greenhouse Collection. You can choose between polished brass, brushed brass or chrome.



### COLD FRAME

Cold frames are a welcome accessory for your greenhouse. In the cold bench, you can harden off seedlings before they go out into the open field, you can grow primroses or picky herbs. A cold bench also serves as excellent storage. Our cold benches are opened with a gas lifter and do not need supports to stay up. The cold bench is an accessory that you add to your order.

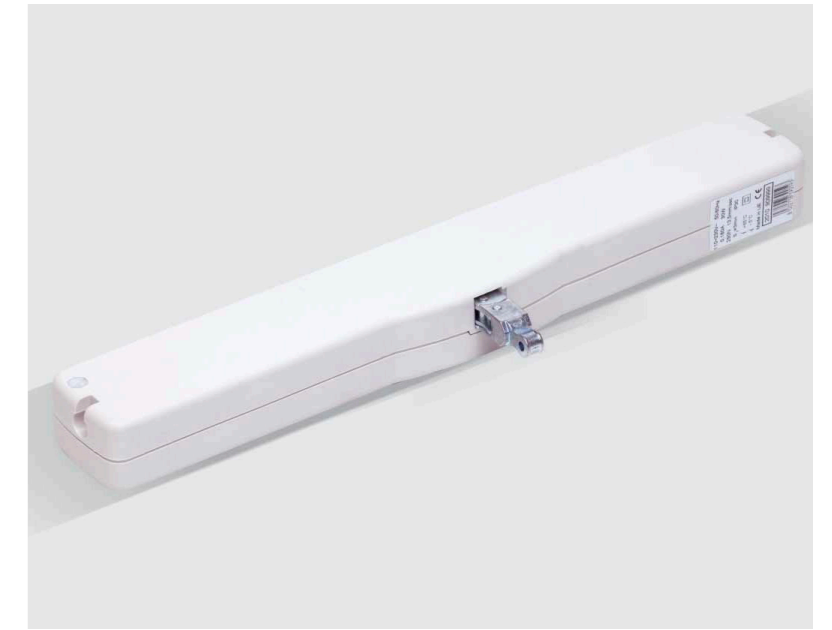

### MOTROSED OPENING

If you want to replace your autovents with a motorized opener for the roof ventilation, our motor CLOUD is a possibility. A small, elegant engine that is perfectly suited to our petite profile. The motors are connected in groups and can be connected to any control unit. 110-230V AC 50/60Hz. Standard colours: BLACK (circa RAL9005), WHITE (circa RAL9016), and GRAY (circa RAL7047).

# LIGHTING

Modell A

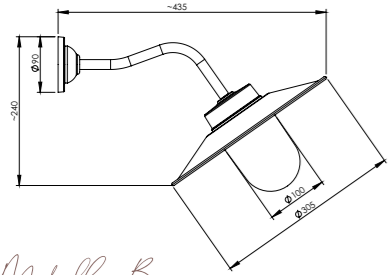

Modell B

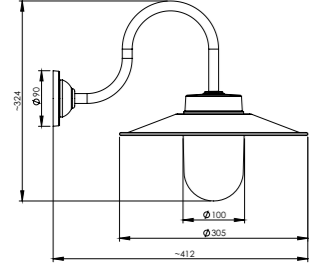

Modell C

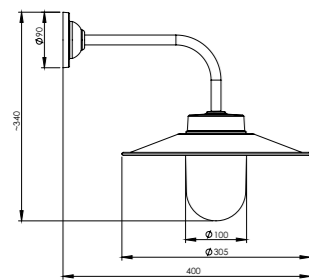

Our nice stable lamp can be placed on corner posts or above the door. You consult about the placement when you place your order and you have three alternative arms to choose from.

Modell D

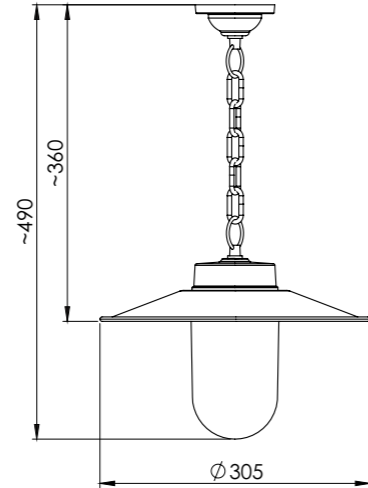

Modell E

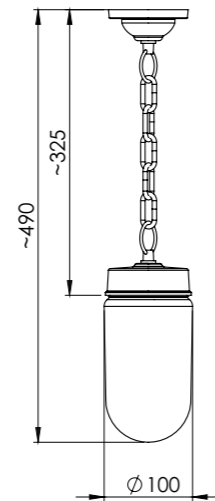

Inside there are two hanging lamps to choose from. The lamp is hung on a chain and your order includes a specially adapted mounting plate that is mounted in the roof ridge.

You can get your luminaire in the same RAL color as the greenhouse or in a different one. The screen is also available as an option in brass.



## MAKE YOUR GREENHOUSE DREAM COME THRU!

Call us or email and tell us about your plans, one calls can provide you with answers to many questions.

Choose a standard or let us make your greenhouse completely Unique

No matter where in the country you are, you can get help with the whole building.

The assembly is included in the price.

With over 30 years of experience, we help you complete your greenhouse projects with the best conditions.



The cover photo is created by  
<https://www.instagram.com/ellenflws/>



Please contact us at  
0046 (0) 8 520 274 80  
[www.vanstabotanic.com](http://www.vanstabotanic.com)

contact